

NATIONAL CAPITAL PLANNING COMMISSION
FORT LINCOLN PARK
PRELIMINARY REVIEW SUBMISSION

2 OCTOBER 2020



FORT LINCOLN PARK SITE OVERVIEW



- 
- **ENHANCE A VIBRANT COMMUNITY HUB**
 - **REVIVE THE EXISTING LANDSCAPE & PARK**
 - **CELEBRATE THE RICH SITE HISTORY**
 - **ENCOURAGE AN INTERGENERATIONAL EXPERIENCE**
 - **CREATE A MODEL NEIGHBORHOOD AMENITY**

FORT LINCOLN PARK HISTORIC OVERVIEW - TIME LINE

BATTLE OF BLADENSBURG: On the hill that will one day become Fort Lincoln, Commodore Joshua Barney and his troops hold off the British, before being overcome. The British force advance to burn the White House



PAINTING BY CHARLES WATERHOUSE (1814)

THE NATIONAL TRAINING SCHOOL FOR BOYS opens on the former site of Fort Lincoln on January 13, 1870. Part of the Bureau of Prisons, it was "an institution committed to the task of retraining and redirecting youths who have violated the laws of the United States and the District of Columbia". (U.S. Bureau of Prisons, 1953) It closes in 1968.



National Training School for Boys, U.S. Bureau of Prisons, (1953).

THEODORE HAGANS, an eminent local businessman and Civil Rights leader is selected by the District to lead the redevelopment of Fort Lincoln. In 1984, after Hagans dies in a plane crash, his daughter, Dr. Michelle Hagans takes over the Fort Lincoln Redevelopment Corporation.

Fry & Welch Architects design the Fort Lincoln (Thurgood Marshall) Elementary School which is completed ca. 1975 and demolished in 2020.

Landscape architect M. Paul Friedberg designs Fort Lincoln Commemorative Park, which is completed in 1980 and survives with integrity today.



WAR OF 1812

CIVIL WAR

GREAT SOCIETY

URBAN DEVELOPMENT

1812

1861

1870

1967

1975

2013

2020

FORT LINCOLN is constructed as part of a series of fortifications to defend the capital which include Fort Totten and Fort Reno among others. When African Americans are admitted to the U.S. Army two years later, many are assigned to the Defenses of Washington

4th U.S. Colored Infantry at Fort Lincoln, Library of Congress



"Once let the black man get upon his person the brass letters, U.S., let him get an eagle on his button, and a musket on his shoulder, and bullets in his pockets, and there is no power on earth which can deny that he has earned the right to citizenship in the United States." - Frederick Douglass

<https://www.nps.gov/articles/african-african-americans-and-the-civil-war-forts-of-dc.htm>

THE FORT LINCOLN URBAN RENEWAL AREA, a new community to be developed on the former reform school site is announced by LBJ to help relieve housing shortages. The plan calls for 4,500 housing units for different income and family sizes. It additionally calls for new schools and community amenities including a library, health center, fire station and rail transit.

THURGOOD MARSHALL ELEMENTARY SCHOOL CLOSES.

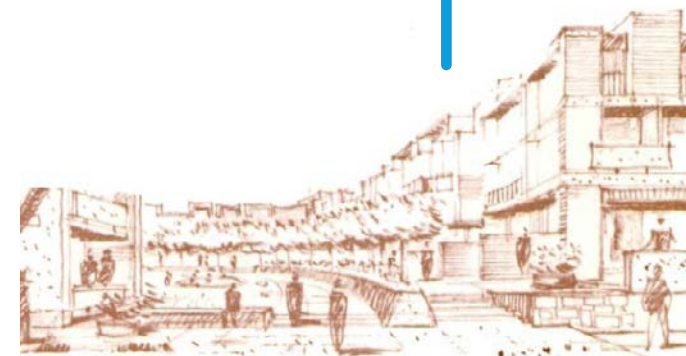

"Washington needs and deserves the best in community planning - and this new development can be the best of communities. It should offer a full range of educational, recreation, and other public services to the citizens of every station." - Lyndon Johnson.

"Fort Lincoln Urban Renewal Area" District of Columbia, National Capital Planning Commission, Redevelopment Land Agency

FORT LINCOLN PARK SITE ANALYSIS - HISTORIC CORE

THE SITE OFFERED FRIEDBERG UNIQUE ADVANTAGES:

1. IRREGULAR FORM, NOT DEFINED BY THE GRID OF THE CITY.
2. TOPOGRAPHIC VARIATION AND SIGNIFICANT GRADE CHANGES.
3. PANORAMIC VIEWS FROM VIEWER SUPERIOR LOCATIONS.
4. RICH EMBEDDED HISTORY.

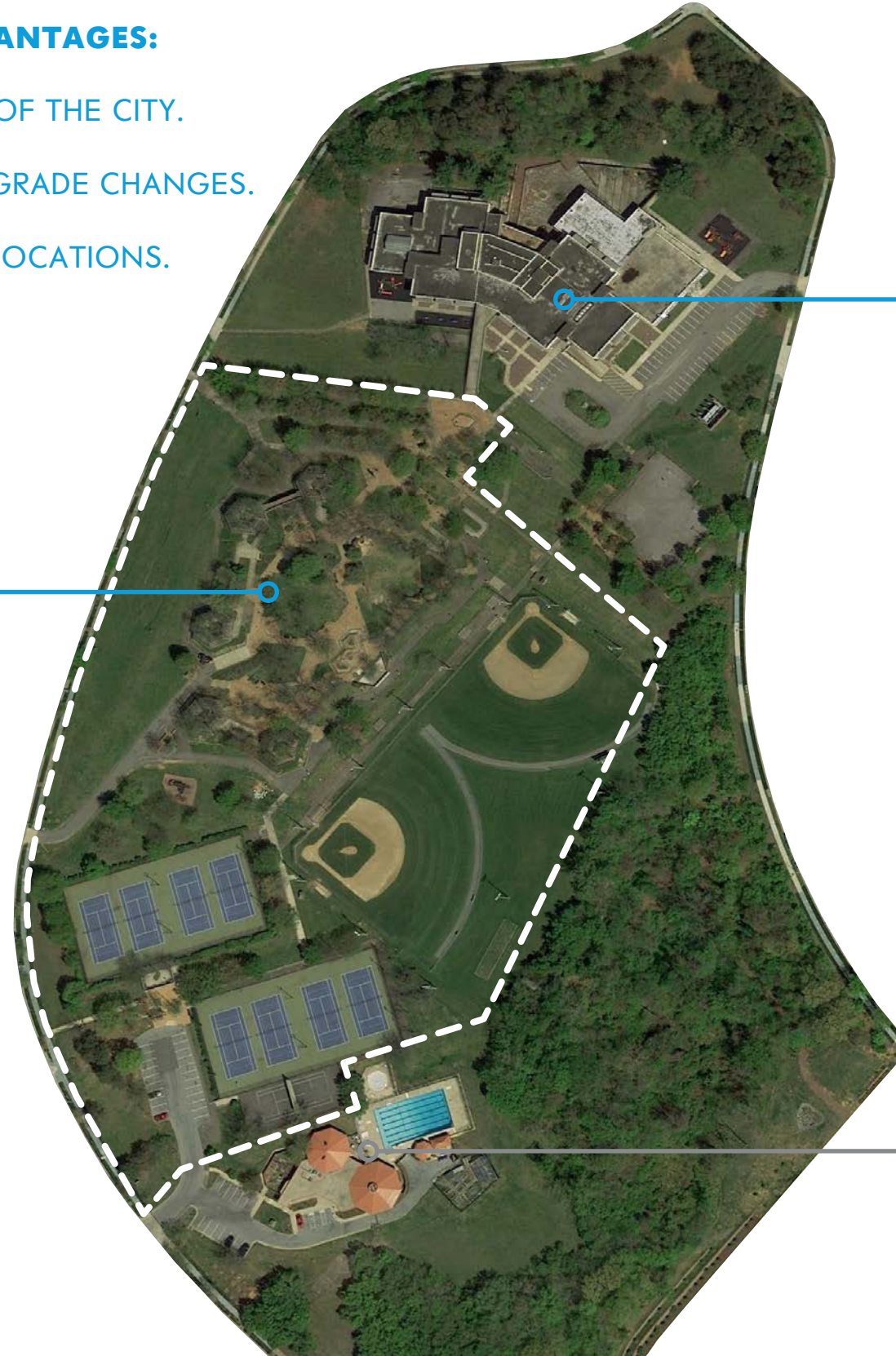

HISTORIC CORE
FORT LINCOLN COMMEMORATIVE PARK

LANDSCAPE ARCHITECT: M. PAUL FRIEDBERG
 ARCHITECT: JEROME LINDSAY
 COMPLETED 1980

**FORT LINCOLN PARK
 COMMUNITY CENTER SITE**

FORMER THURGOOD MARSHALL ELEMENTARY
 SCHOOL SITE (DEMOLISHED 2020)
 NOT CONTRIBUTING

FRY & WELCH ARCHITECTS
 COMPLETED CA. 1975
 DEMOLISHED 2020

NOT CONTRIBUTING
**THEODORE HAGANS
 CULTURAL CENTER AND POOL**

ARCHITECT UNKNOWN
 DATE UNKNOWN, RENOVATED CA. 2009

FORT LINCOLN PARK CONTEMPORANEOUS FRIEDBERG DESIGNS



JACOB RIIS HOUSES
PLAYGROUND
NEW YORK, NY
1965



67TH STREET
PLAYGROUND
NEW YORK, NY
1967



PEAVEY PLAZA
PARK & FOUNTAIN
MINNEAPOLIS, MN
1975



LORING GREENWAY
PUBLIC SPACE & FOUNTAIN
MINNEAPOLIS, MN
1976

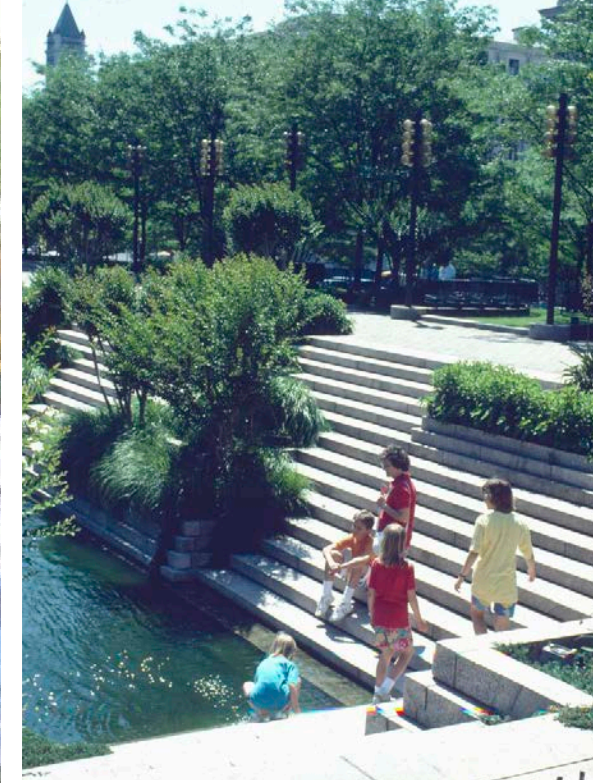

PERSHING PARK
PUBLIC SPACE & WATER FEATURE
WASHINGTON, DC
1981



FORT LINCOLN PARK M. PAUL FRIEDBERG LANDSCAPE ARCHITECT

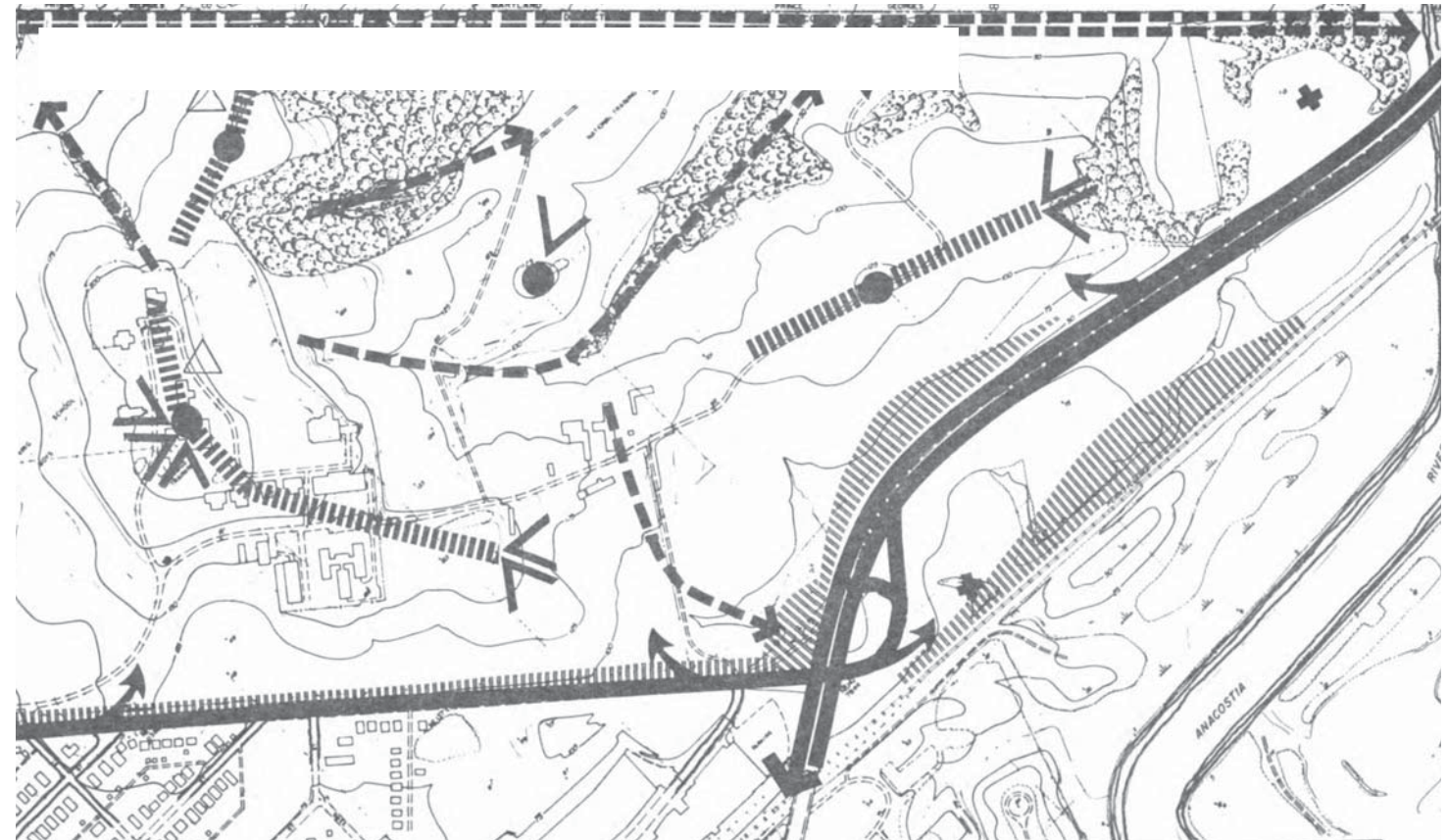
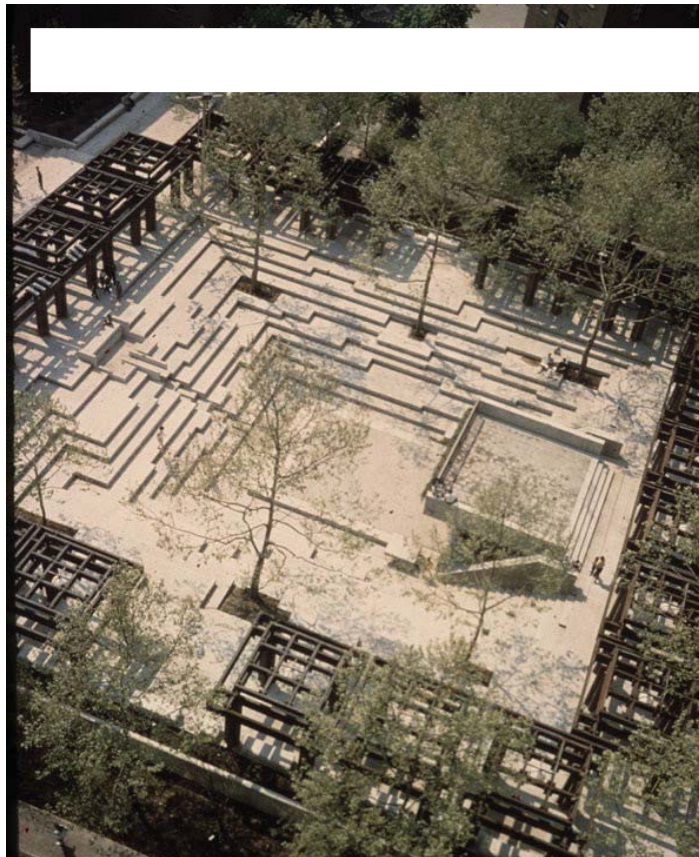
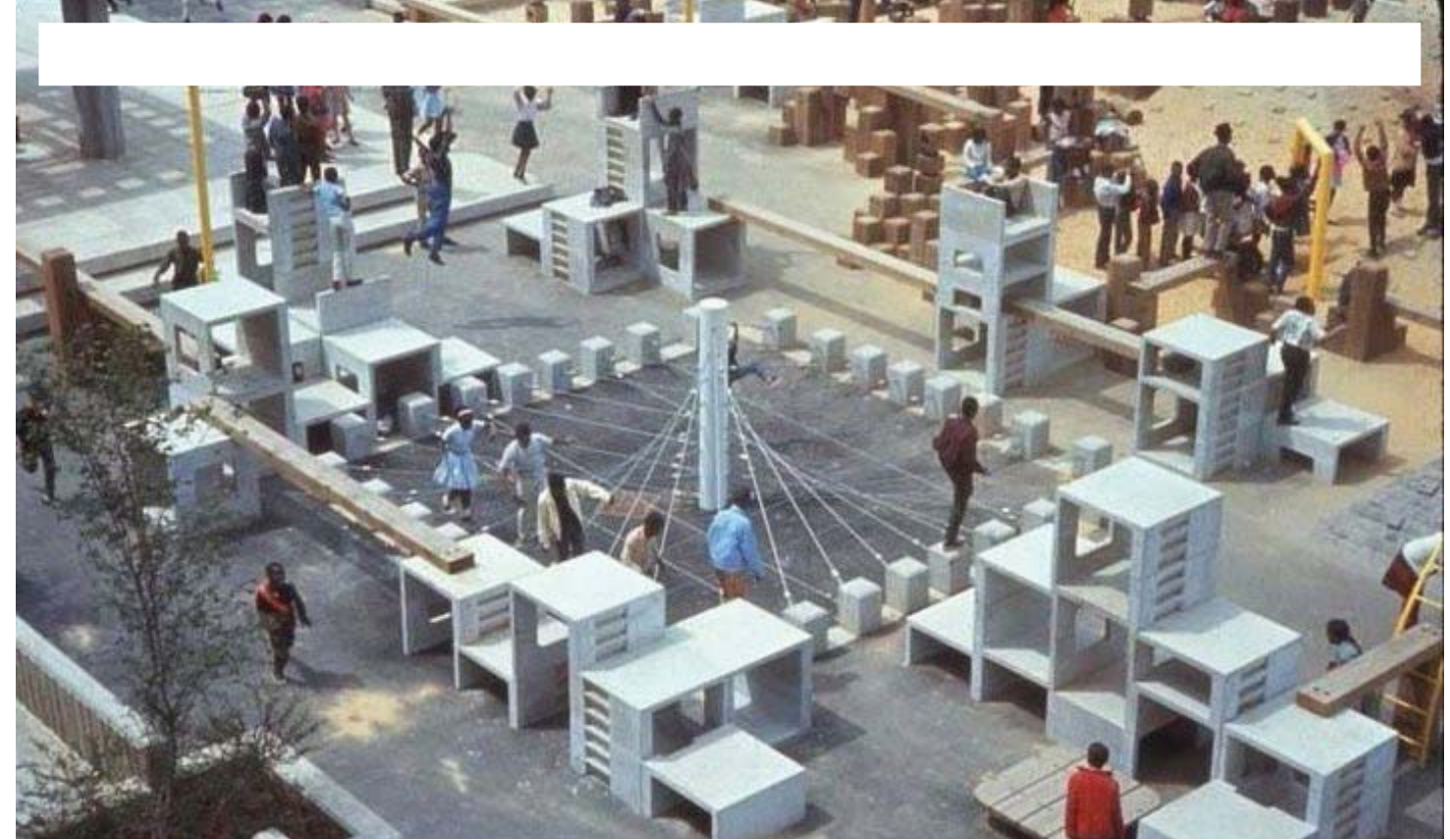
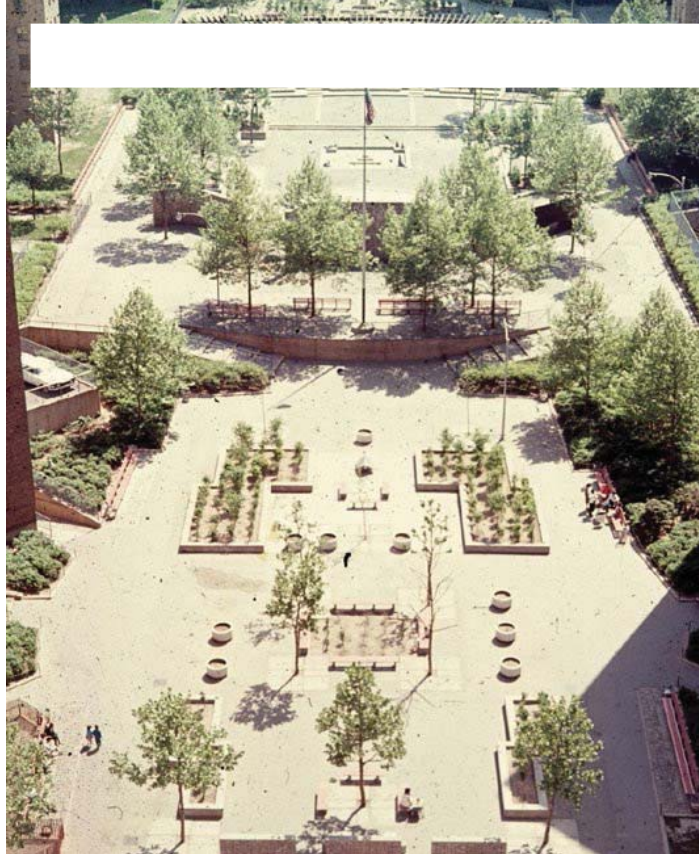

FORT LINCOLN PARK
M. PAUL FRIEDBERG LANDSCAPE ARCHITECT



FORT PLAY AREA
FORT LINCOLN PARK OPENING -- 1979
PHOTOS COURTESY OF THE DC PUBLIC ARCHIVES

LOCKWOOD, GRACE S., ET AL. "RECENT WORKS." LANDSCAPE ARCHITECTURE, VOL. 71, NO. 6, 1981, PP. 734-737. JSTOR, WWW.JSTOR.ORG/STABLE/44671401. ACCESSED 10 AUG. 2020.

FORT LINCOLN PARK DESIGN INTENT AS ESTABLISHED BY M. PAUL FRIEDBERG



FORT LINCOLN PARK
DESIGN INTENT AS ESTABLISHED BY M. PAUL FRIEDBERG

“THE ASSISTANT SECRETARY INTRODUCED MR. STANLEY SHERMAN OF THE D.C. DEPARTMENT OF HOUSING AND COMMUNITY DEVELOPMENT, MR. M. PAUL FRIEDBERG, LANDSCAPE ARCHITECT, AND MR. JEROME LINDSAY, ARCHITECT, WHO PRESENTED DRAWINGS AND A MODEL FOR A PLAN AREA TO BE DEVELOPED ON THE SITE OF OLD FORT LINCOLN, NEAR THE MARYLAND LINE AND THE ANACOSTIA RIVER. **MR. FRIEDBERG EXPLAINED THAT AS THERE ARE NO ARCHAEOLOGICAL REMAINS OF THE FORT NO ATTEMPT HAD BEEN MADE AT RECONSTRUCTION. RATHER, THE SUGGESTION OF A FORT HAD BEEN REINFORCED BY THE CONFIGURATION OF THE PLAY AREA AND BY THE DESIGN OF CERTAIN ELEMENTS WITHIN THE SPACE. MR. FRIEDBERG SAID THE SEEMINGLY COMPLEX DESIGN RESULTED FROM THE DESIRE TO CREATE A SENSE OF CONSTANT DISCOVERY WITHIN THE PLAY AREA. HE DESCRIBED VARIOUS FEATURES OF THE DESIGN – A FOUNTAIN, EXHIBIT SPACE, LAWNS, OVERLOOKS, AND PLACES TO SIT, AS WELL AS THE MATERIALS TO BE USED.** THE MEMBERS QUESTIONED THE USE OF LARGE TREES IN SOME ADJACENT AREAS WHICH MIGHT OBSCURE THE FINE VIEW OF THE CITY FROM THE SITE, BUT APPROVED THE DESIGN UNANIMOUSLY.”

— CFA MEETING MINUTES APRIL 21, 1976

FORT LINCOLN PARK EXISTING CONDITIONS: HISTORIC CORE



FORT LINCOLN PARK EXISTING CONDITIONS: HISTORIC CORE



SPECIAL SQUARE & RECTANGLE PATTERN
PICNIC AREA ADJACENT TO PAVILIONS



SQUARE PAVER, RUNNING BOND
AMPHITHEATER TERRACE



HEXAGON PAVER
AMPHITHEATER



SPECIAL SQUARE & RECTANGLE PATTERN -
CORNER DETAIL; PICNIC AREA ADJACENT TO PAVILIONS



SQUARE PAVER, DIAMOND BOND
AMPHITHEATER PLATFORM AND ENTRY BATHROOM AREA



FORT PLAY AREA BRICK SCRAMBLE PAVERS

FORT LINCOLN PARK EXISTING CONDITIONS: HISTORIC CORE

TYPICAL PAVILION

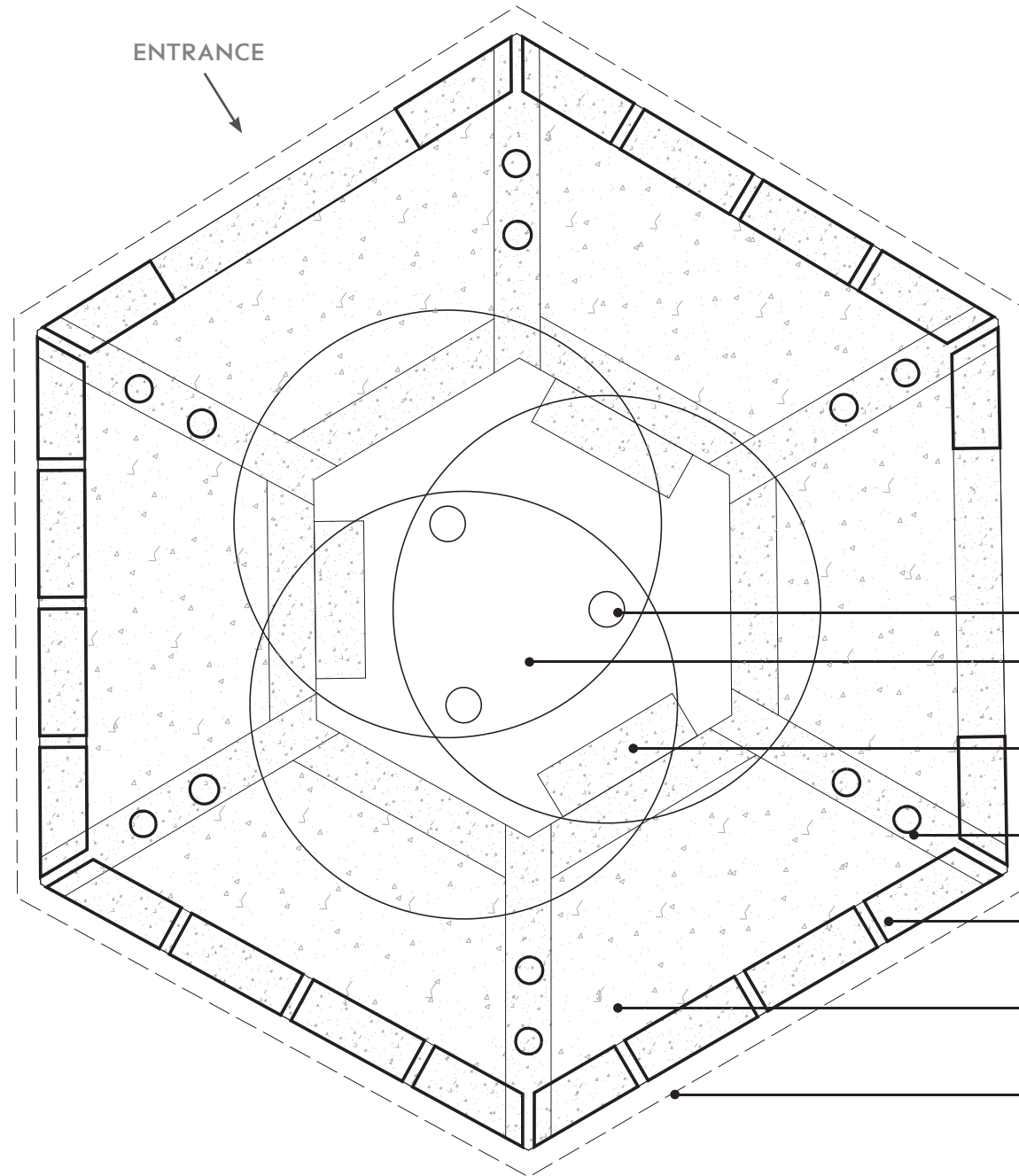

- THORNLESS HONEYLOCUST
- PLANTING AREA - EXPOSED SOIL
- BRUSHED CONCRETE;
PAD FOR TRADITIONAL BENCH
- TYP. CONCRETE DOUBLE COLUMNS
- BRUSHED CONCRETE BENCH
- EXPOSED AGGREGATE CONCRETE
- WOOD AWNING OVERHEAD

FORT LINCOLN PARK EXISTING CONDITIONS: HISTORIC CORE

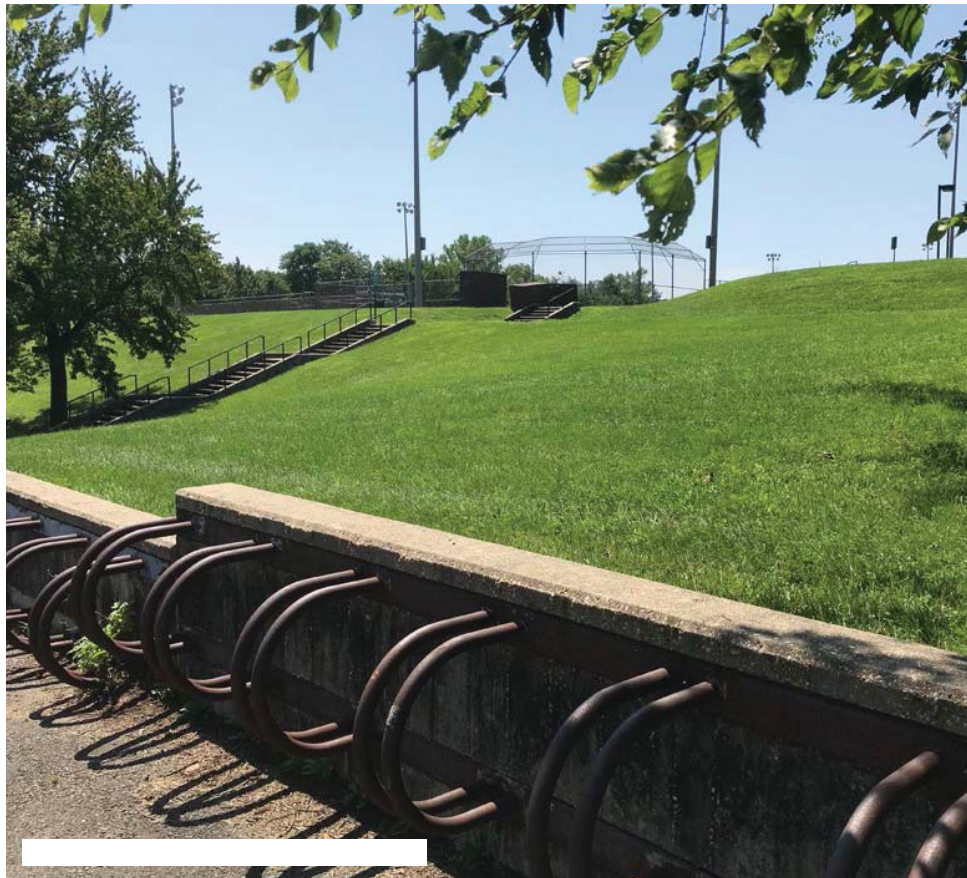

HISTORIC CORE FORT PLAY AREA - EXISTING CONDITIONS

RAILROAD TIE WALLS

SYNTHETIC TURF
PLAY TERRACE

OPEN PLAY LAWN

'BRICK SCRAMBLE' PAVING

RAILROAD TIE WALLS &
CLIMBING ELEMENTS

FEATURE MOUND;
MISSING 2 SLIDES



RAILROAD TIE WALLS



FEATURE MOUND WITH 'BRICK SCRAMBLE'





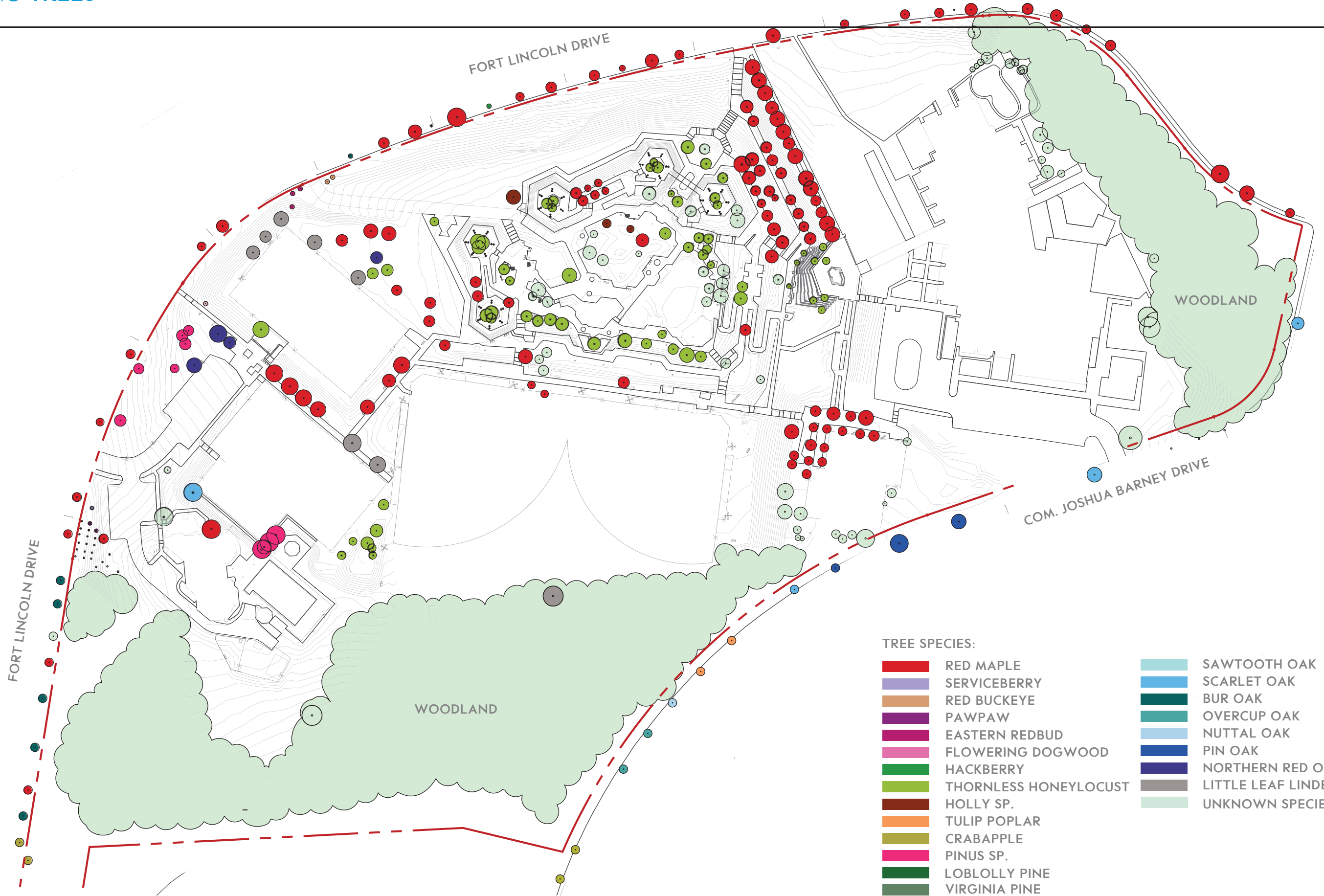

'BRICK SCRAMBLE' PAVING AT PLAY TERRACE

FORT LINCOLN PARK EXISTING TREES



TREE SPECIES:

- | | | | |
|---|-----------------------|---|--------------------|
|  | RED MAPLE |  | SAWTOOTH OAK |
|  | SERVICEBERRY |  | SCARLET OAK |
|  | RED BUCKEYE |  | BUR OAK |
|  | PAWPAW |  | OVERCUP OAK |
|  | EASTERN REDBUD |  | NUTTAL OAK |
|  | FLOWERING DOGWOOD |  | PIN OAK |
|  | HACKBERRY |  | NORTHERN RED OAK |
|  | THORNLESS HONEYLOCUST |  | LITTLE LEAF LINDEN |
|  | HOLLY SP. |  | UNKNOWN SPECIES |
|  | TULIP POPLAR | | |
|  | CRABAPPLE | | |
|  | PINUS SP. | | |
|  | LOBLOLLY PINE | | |
|  | VIRGINIA PINE | | |

FORT LINCOLN PARK RENEWAL



- EMBRACE A HOLISTIC APPROACH TO STEWARDSHIP AT FORT LINCOLN PARK THAT UNDERSTANDS AND VALUES ITS INHERENT AND UNIQUE NATURAL, HISTORIC, AND CULTURAL ASSETS
- ESTABLISH A “HISTORIC CORE” AREA WITHIN FORT LINCOLN PARK TO GUIDE INTERVENTION
- REHABILITATE THE INTEGRITY OF M. PAUL FRIEDBERG’S 1980 LANDSCAPE DESIGN INSIDE THE HISTORIC CORE WITHIN A CONTEMPORARY CONTEXT OF ACCESSIBILITY AND SECURITY

WHEN APPLYING THE STANDARDS OF REHABILITATION:

- BALANCE ACTIVITY & PROGRAMMING ACROSS THE ENTIRE PARK - “THE PARK JUST GOT BIGGER!”
- REFINE & REINFORCE PATH NETWORK TO IMPROVE FUNCTION AND UNIVERSAL ACCESS
- REINTERPRET ORIGINAL PLAY AREAS AS SAFE AND ACCESSIBLE AMENITIES
- REJUVENATE SOILS, LAWNS, AND SITE PLANTINGS. ASSESS ORIGINAL AND EXISTING TREE LOCATIONS & HEALTH TO ESTABLISH A PROPOSED PLANTING STRATEGY THAT ENSURES FUTURE CANOPY COVER
- REUSE, REFURBISH, OR REPLACE SITE FIXTURES AND FURNISHINGS WHILE IMPROVING SAFETY AND UNIVERSAL ACCESSIBILITY.

FORT LINCOLN PARK SITE MASTERPLAN: CIRCULATION SYSTEM



-  PRIMARY PEDESTRIAN SPINE
-  PARK CIRCULATION
-  VEHICULAR ACCESS

FORT LINCOLN PARK SITE MASTERPLAN

"THE PARK JUST GOT BIGGER!"

COMMUNITY CENTER

- CREATE ACCESSIBLE CONNECTIONS TO THE COMMUNITY
- CREATE A SEAMLESS CONNECTION TO THE EXISTING PARK.
- OPEN FIELDS FOR INFORMAL ACTIVE PLAY
- NEW OUTDOOR CLASSROOMS; DEMONSTRATION KITCHEN, FITNESS SPACES, AND FLEXIBLE AMPHITHEATER.
- NEW PLAYGROUND (2-5 YEAR OLDS)
- NEW PLANTING AND SUSTAINABLE FEATURES INCLUDING INCREASED CANOPY COVER, MEADOWS, RAIN GARDENS, AND GREEN ROOFS

THEODORE HAGANS CULTURAL CENTER

- CREATE ACCESSIBLE CONNECTIONS TO THE COMMUNITY
- CREATE SEAMLESS CONNECTIONS TO PARK PATHWAYS AND NEW FITNESS TRAIL
- EXPAND THE COMMUNITY GARDEN
- REHABILITATE THE POOL DECK



HISTORIC CORE

- REHABILITATE FORT PLAY AREA
- EXISTING FOUNTAIN STRUCTURE TO REMAIN
- REHABILITATE PAVILION STRUCTURES AND PAVING
- PRESERVE AND REJUVENATE EXISTING TREES AND ENHANCE THE DESIGN INTENT WITH NEW PLANTING
- REHABILITATE DAMAGED PAVING
- RENOVATE PATHWAYS TO IMPROVE ACCESSIBILITY

FORT LINCOLN PARK EXISTING AND PROPOSED TREES

- CANOPY DECIDUOUS
- EVERGREEN
- FLOWERING
- EXISTING TREE

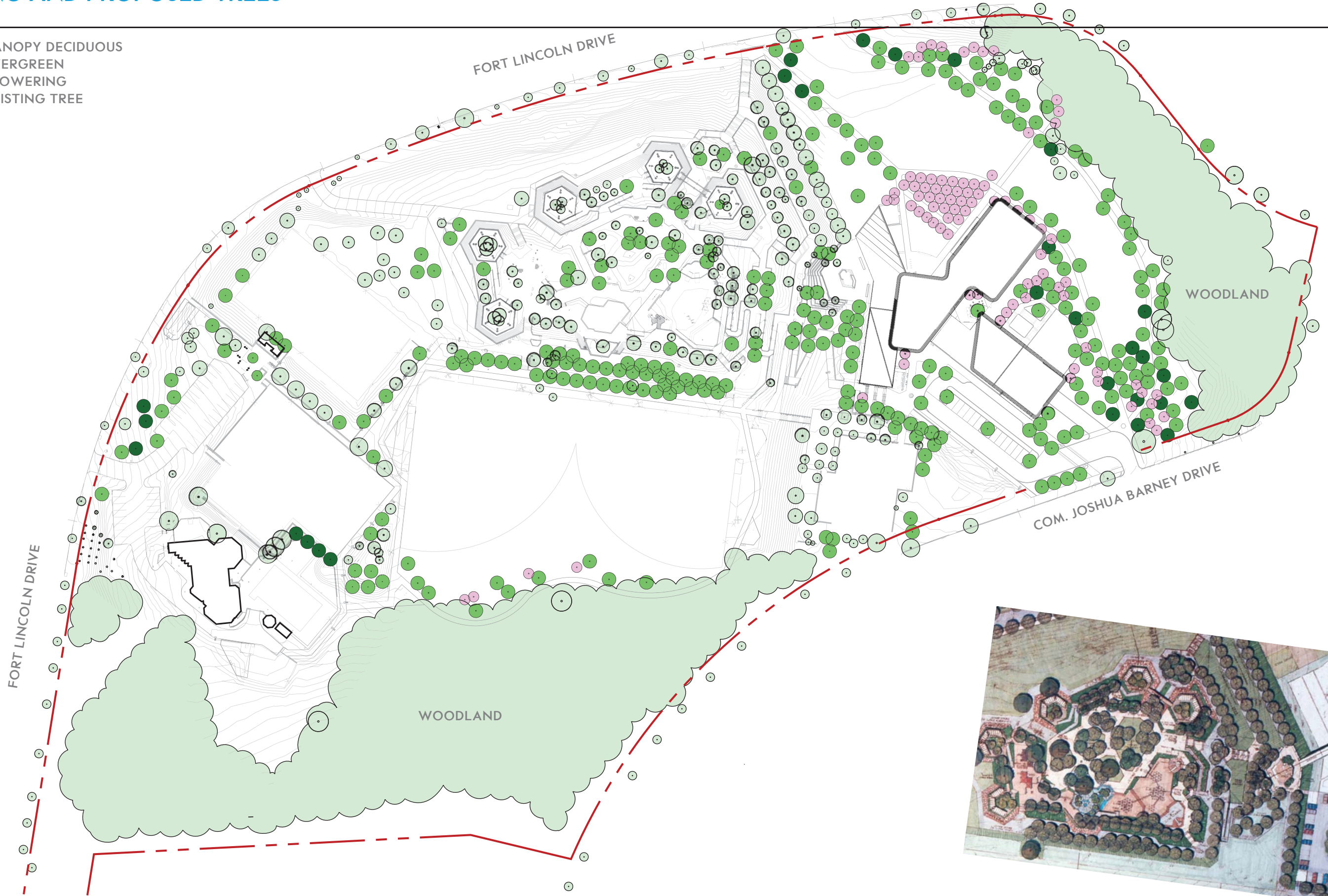

FORT LINCOLN PARK PROPOSED SPECIES



RED MAPLE



SERVICEBERRY



FLOWERING DOGWOOD



HACKBERRY



YELLOWWOOD



THORNLESS HONEYLOCUST



WITCH HAZEL



TULIP POPLAR



AMERICAN SYCAMORE



LOBLOLLY PINE



VIRGINIA PINE



SCARLET OAK



NUTTAL OAK



PIN OAK



NORTHERN RED OAK



LITTLE LEAF LINDEN



BALD CYPRESS



YOSHINO CHERRY

HISTORIC CORE LANDSCAPE STRATEGIES

CLEAR INVASIVES AND UNDERSTORY TO RETURN TO ORIGINAL DESIGN INTENT

REPAIR AND REPLACE PAVING AS NECESSARY; PROVIDE TREE PROTECTION FOR EXISTING TREES

REPLACE ASPHALT PATH

REPAIR AND REPLACE BRICK PAVING AS NECESSARY

REGRADE RAMP FOR ADA ACCESSIBILITY

REPLACE ASPHALT WITH SQUARE-PRESSED CONCRETE

NEW GRILLS AND PICNIC TABLES

REMOVE "PLOP" PLAYGROUND

EXISTING PATH

NEW ADA RAMP

REPAIR PAVERS IN PODIUM AREA

PRIMARY ACCESS TO NEW BUILDING; RETAINING WALLS AND RAMPS

RAMP CONNECTION FROM SPINE TO PRIMARY RAMPING SYSTEM

FORT PLAY AREA

FULLY RESTORE FOUNTAIN; ALT. ONLY RESTORE BRICK

HEXAGON ASPHALT PAVERS; NEW BLEACHERS

NEW FITNESS TRAIL; PERMEABLE ASPHALT

FOREST EDGE PLANTING

4 NEW FITNESS STATIONS



HISTORIC CORE FORT PLAY AREA - PROPOSED

PLAY MOUND:
REPLACE BRICK SCRAMBLE,
REPLACE 2 SLIDES;
REPLACE TIMBER CLIMBERS

1 ADD TIMBERFORM
CLIMBING ELEMENT

6 REPLACE TIMBER
WALL /CLIMBING &
BALANCE ELEMENTS

5 SEESAW

ENGINEERED
WOOD FIBER (EWF)

3 ADD TIMBERFORM
BALANCE ELEMENT

2 MUSICAL PLAY ELEMENTS

ADD EXTERNAL CIRCULATION
LAWN

RESTORE BRICK SCRAMBLE
NEW ADA ACCESS

4 REPLACE TIMBER WALL;
ADD PLAY STRUCTURE
WITH ADA BRIDGE
CONNECTION

RENOVATE FOUNTAIN;
ALT. ONLY RESTORE
DAMAGED BRICK WORK

FOUNTAIN EQUIPMENT
ROOM AND STORAGE



HISTORIC CORE FORT PLAY AREA - PROPOSED



1 CLIMBING ELEMENT - TIMBERFORM



2 MUSIC PLAY - TUBULAR BELLS



3 BALANCE BEAMS / BENCHES - TIMBERFORM



4 BRIDGE CONNECTION - TIMBERFORM



5 SEESAW
TIMBERFORMS



6 LOG STACK; EARTHSCAPE

HISTORIC CORE FORT PLAY AREA – SECTIONS

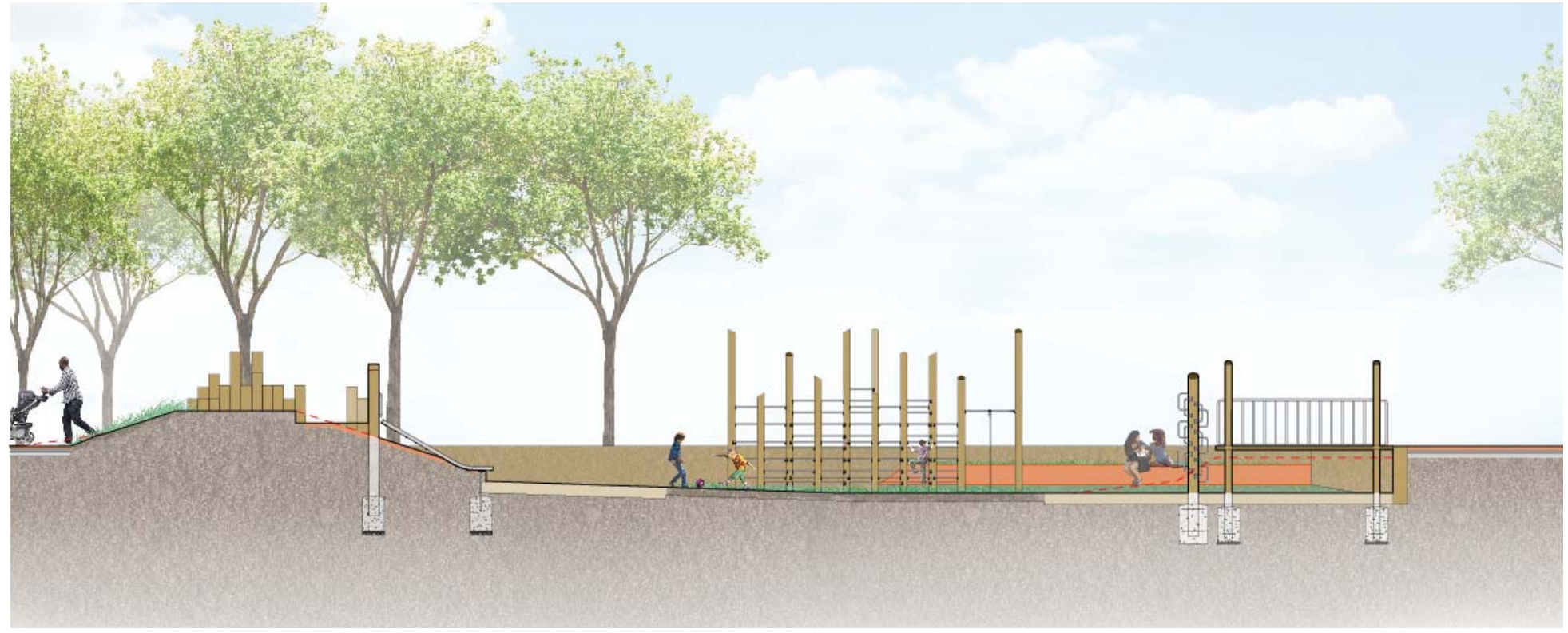
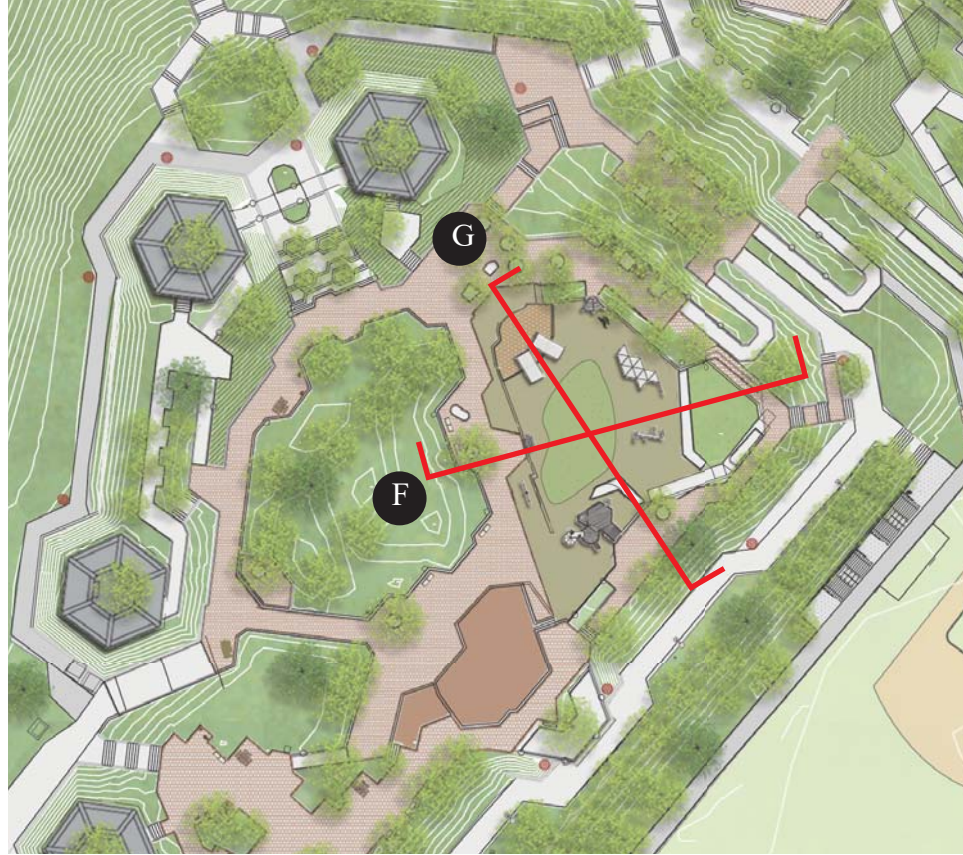

G FORT PLAY AREA

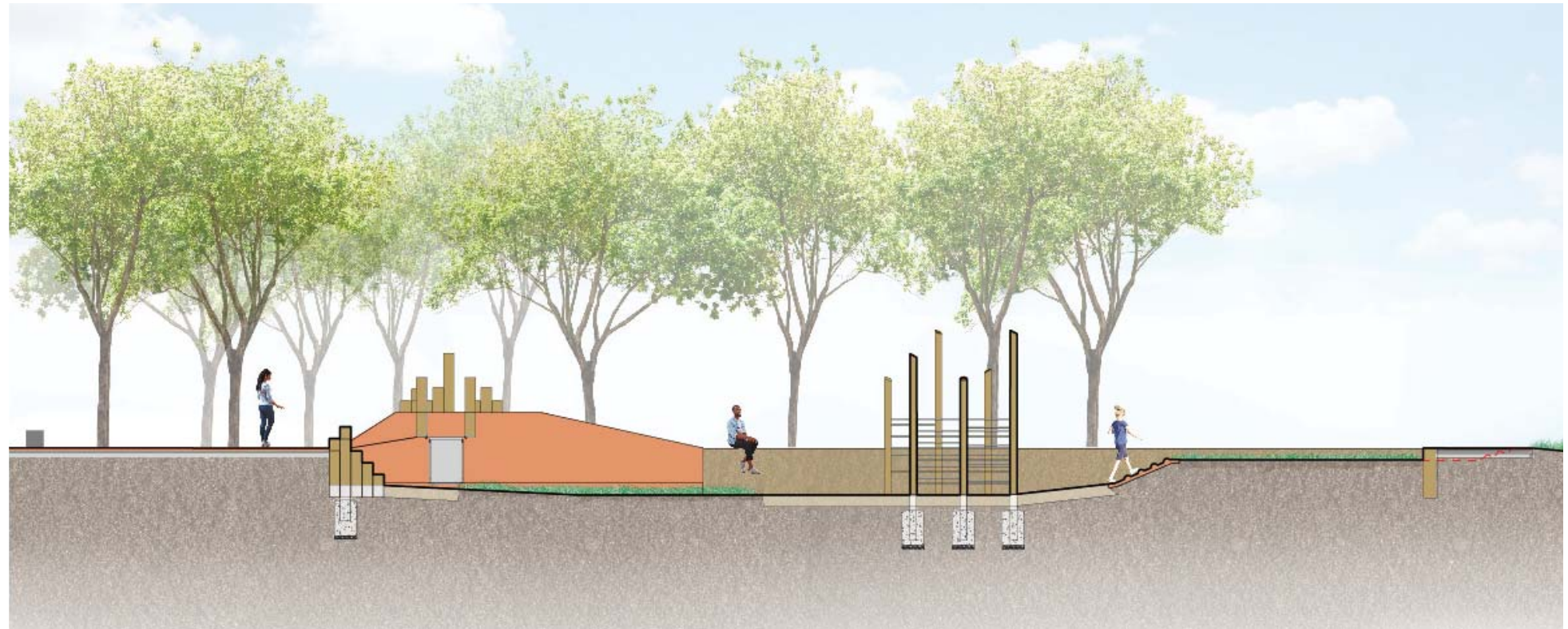

F FORT PLAY AREA

THEODORE HAGANS CULTURAL CENTER LANDSCAPE STRATEGIES

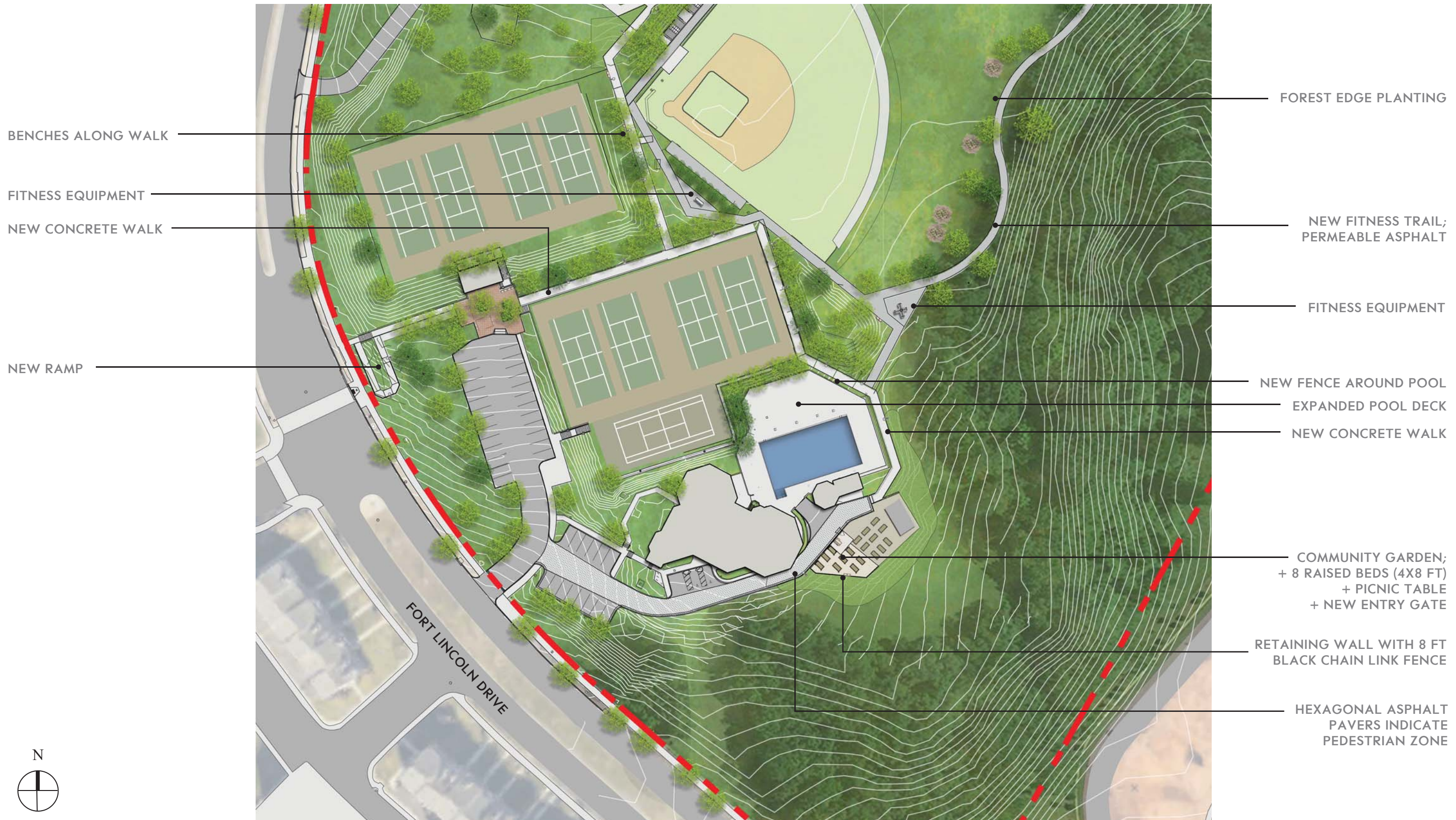

THEODORE HAGANS CULTURAL CENTER LANDSCAPE STRATEGIES



COMMUNITY GARDENS



ADA ACCESSIBLE GARDEN BEDS

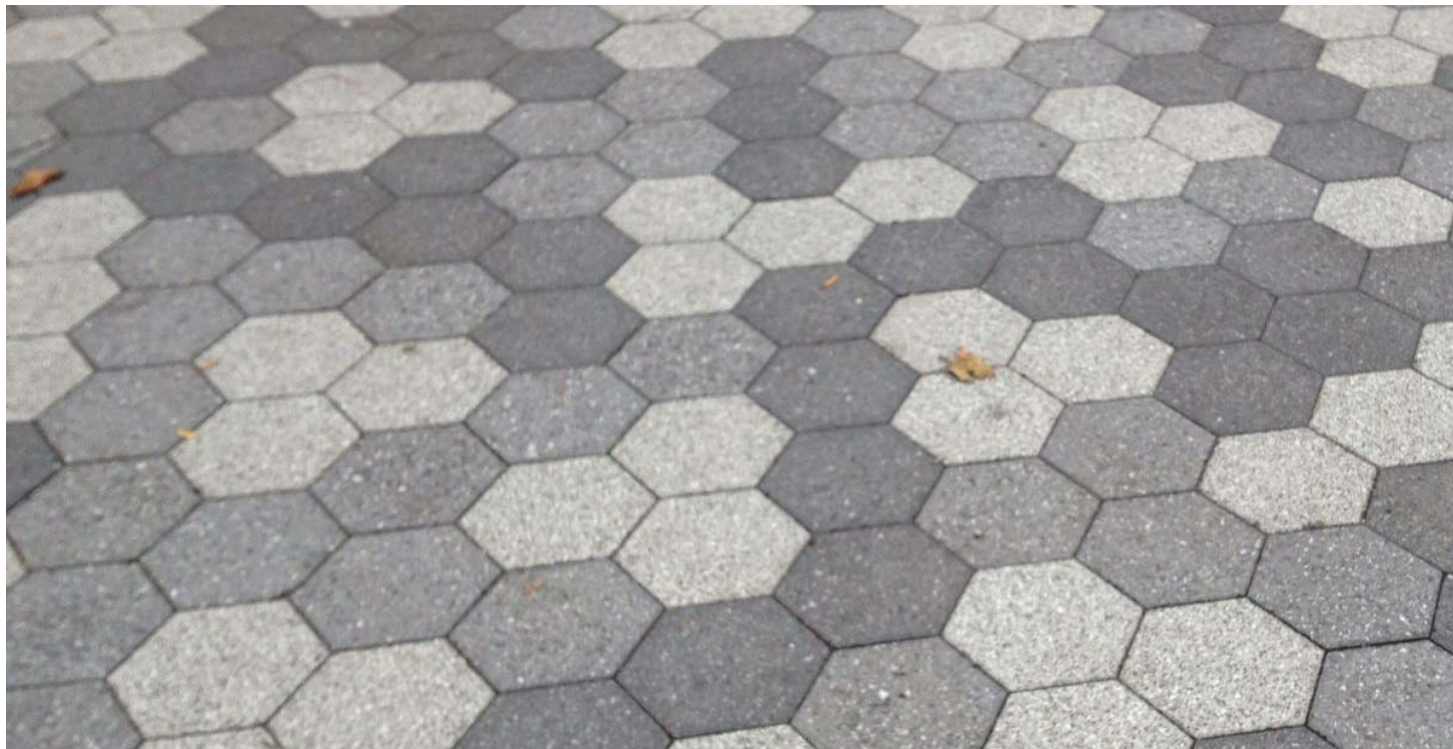

HEXAGONAL ASPHALT PAVERS INDICATE PEDESTRIAN ZONE

THEODORE HAGANS CULTURAL CENTER SECTIONS

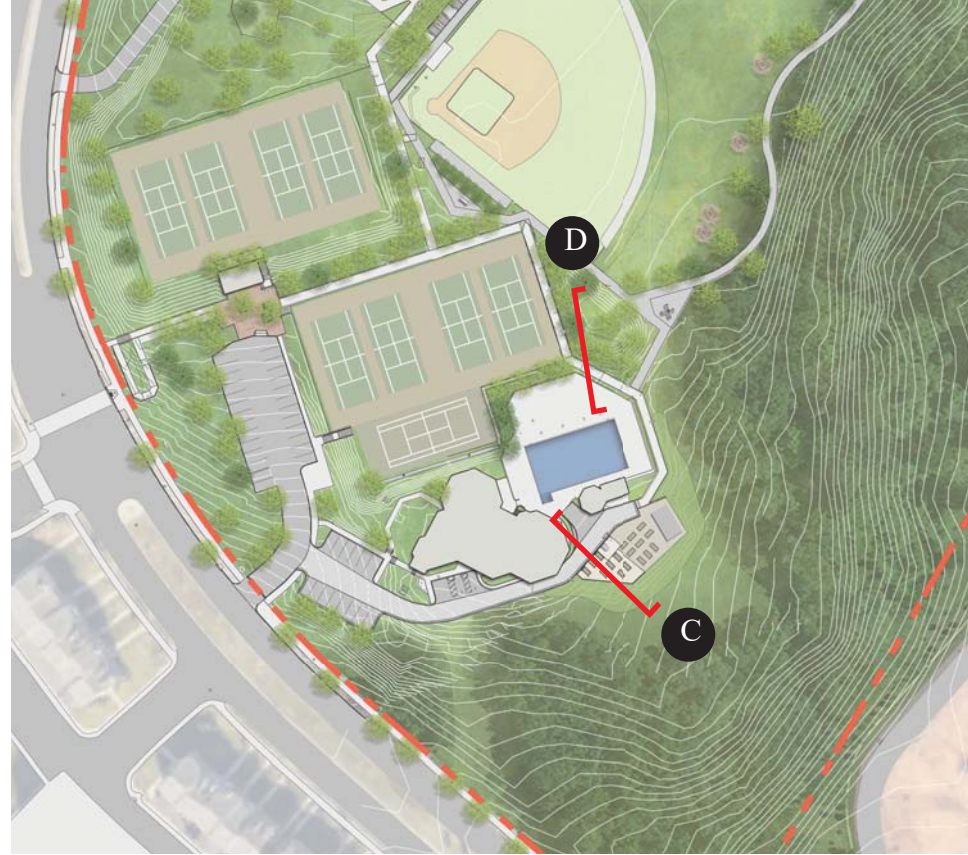

D NEW ACCESSIBLE PATH BY EXPANDED POOL DECK



C EXPANDED COMMUNITY GARDEN

FORT LINCOLN PARK FURNISHINGS

